

S2406-48 Vanity Installation Instruction

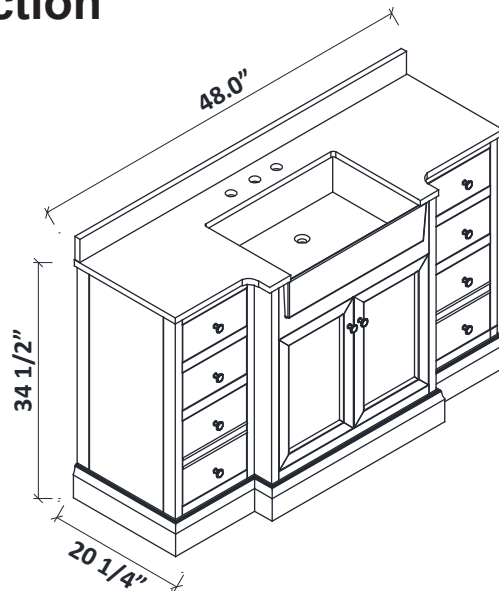

DIMENSIONS

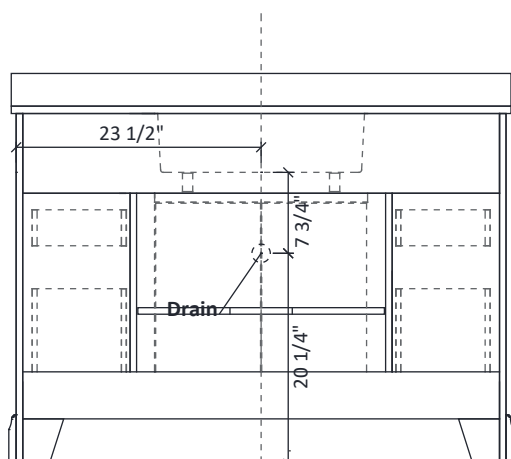
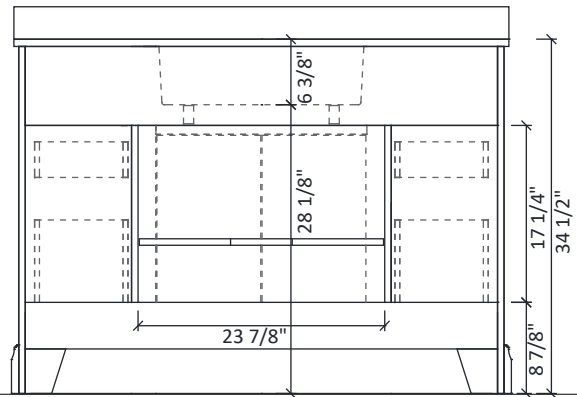
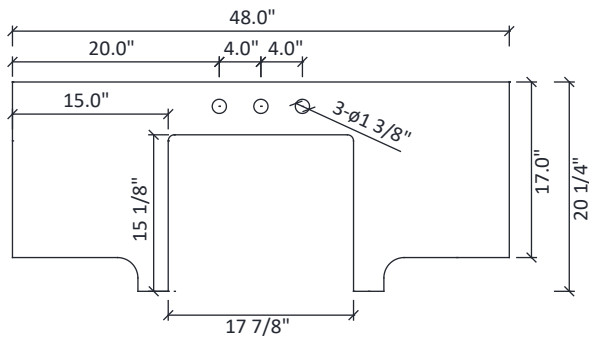

WARNING !

In the hole on the wall, please be sure to be careful to avoid the internal cables and pipelines.

MATERIALS & TOOLS

Safety glasses, Pencil, Level, Tape measure, Stud Finder, Assorted screwdrivers, Assorted Wrenches, Drill, Screw gun, Caulking gun, Hammer, Screws, Nail anchors/Molly screws.

► Backsplash installation

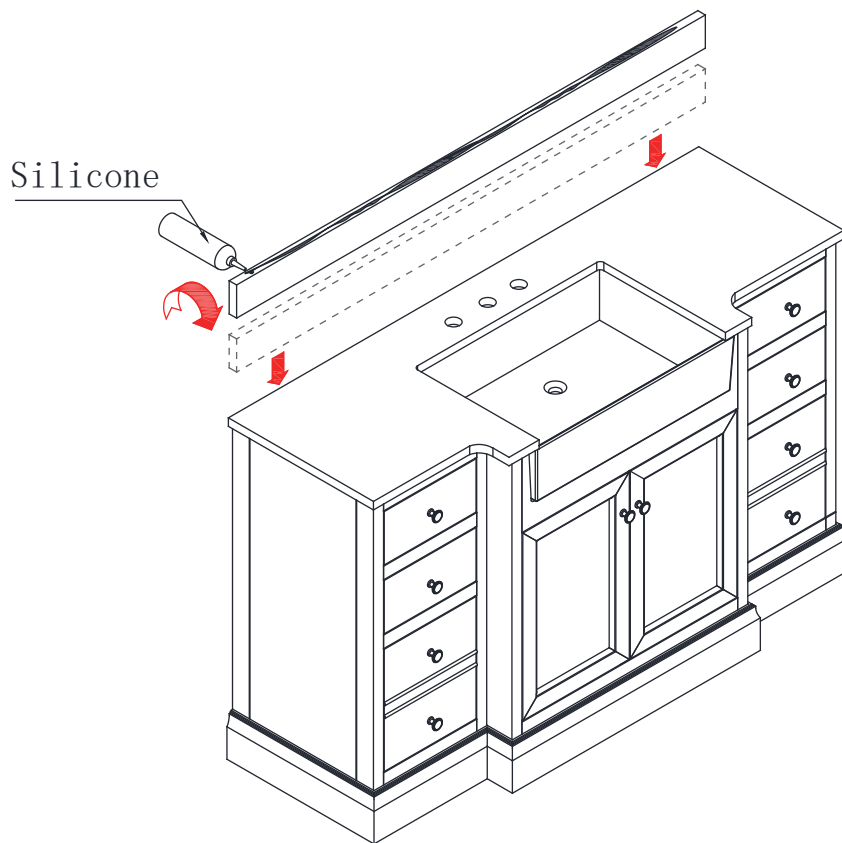

► If the floor is uneven, the adjustable feet levelers can be rotated to raise the vanity to the desired height.

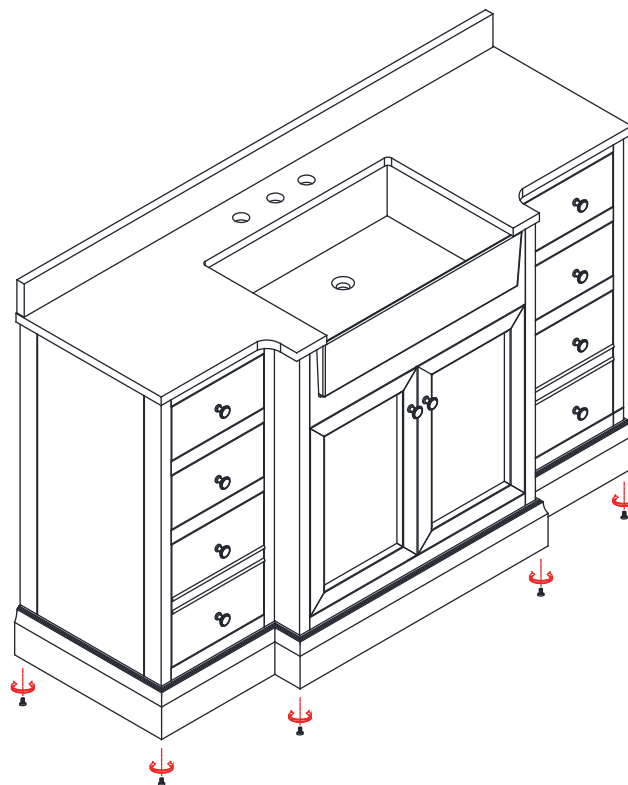

Drain Installation Instruction



Drain Parts
Not Included In The Package

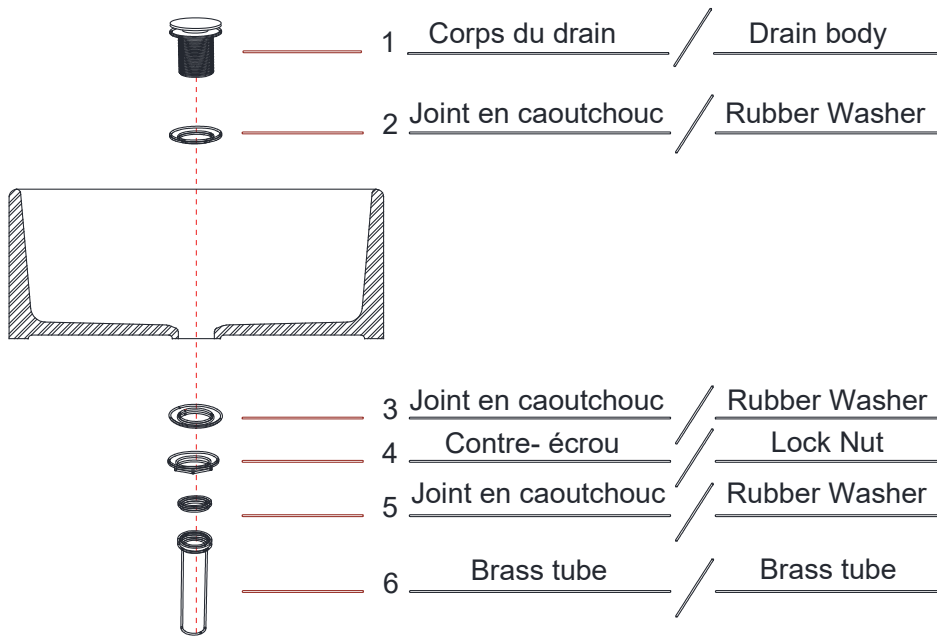
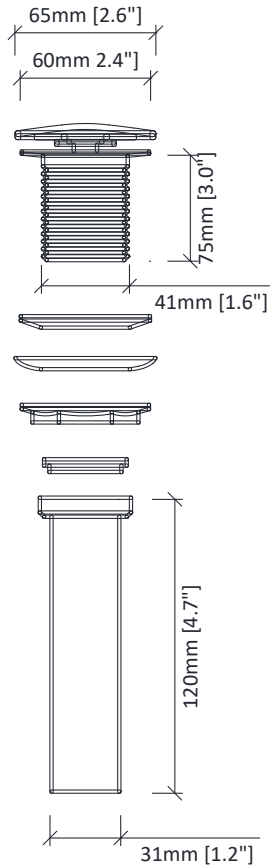

WARNING !

In the hole on the wall, please be sure to be careful to avoid the internal cables and pipelines.